



Bathroom Cabinet

Plan No. 915

Copyright U-Build, Inc., 2000.
All rights reserved. Printed in the U.S.A.

With storage space at a premium in most homes, antique medical cabinets have become a popular (and expensive) way to add storage space to the bathroom. This do-it-yourself version, based on a classic doctor's cabinet, includes the gleaming display space, generous storage and bright white finish of the originals, but without the expense of an antique.

Perfect for linens and toiletries, the project makes a great addition to the powder room. With its clean lines and pleasing proportions, it's also at home in the kitchen or dining room as a handsome curio cabinet.

The bathroom cabinet measures 68 inches tall by 24 inches wide by 14 inches deep.

Bill of Material

Quantity	Size	Material	Item
1	3/4" x 48" x 96"	birch plywood	F, G, P, S, W, BB, GG
1	1/4" x 48" x 48"	birch plywood	E, O
25 BF*	3/4"	birch	A, B, C, D, H, I, J, K, L, M, N, Q, R, T, U, V, X, Y Z, AA, CC, DD, EE, FF, HH, II
2	1/8" x 9 1/16" x 29 7/16"	tempered glass	sides
1	1/8" x 14 9/16" x 30 1/16"	tempered glass	door
36	3/8" x 2"	dowels	
12	5/16" x 3/4"	glass clips	
12	1/4"	shelf supports	
2 pairs	3/4" x 2 3/4"	full back-to-back wraparound hinges	
2	1 5/8" x 1 3/4"	cupboard latches	
1 box	1"	finish nails	
1 box	1 1/4"	finish nails	
1 small can		wood filler	
1 small bottle		wood glue	
2 quarts		primer	
2 quarts		white paint	

*includes about 20% scrap

NOTES

1. Read all instructions and check materials before beginning work.
2. Read manufacturer's instructions before operating equipment.
3. "Subassembly" means two or more boards put together to make a component of a larger part of the project.
4. Use wood glue on all joints.
5. **Always** wear safety glasses.

Cutting Schedule

Item	Qty	T	W	L	Material	Item	Qty	T	W	L	Material
A	2	3/4"	2 3/8"	30 3/4"	birch	S	1	3/4"	11 5/8"	20 1/2"	birch plywwod
B	2	3/4"	1 5/8"	30 3/4"	birch	T	2	3/4"	2 3/8"	35 3/4"	birch
C	2	3/4"	2 3/8"	8 3/8"	birch	U	2	3/4"	1 5/8"	35 3/4"	birch
D	2	3/4"	6"	8 3/8"	birch	V	4	3/4"	3 1/2"	8 3/8"	birch
E	2	1/4"	9 1/8"	23 1/8"	birch plywood	W	1	3/4"	20 1/2"	35 3/4"	birch plywwod
F	1	3/4"	20 1/2"	30 3/4"	birch plywood	X	2	3/4"	1 5/8"	35 3/4"	birch
G	1	3/4"	11 5/8"	20 1/2"	birch plywood	Y	1	3/4"	1 1/2"	18 3/4"	birch
H	2	3/4"	1 5/8"	30 3/4"	birch	Z	2	3/4"	2 3/8"	34 1/8"	birch
I	1	3/4"	1 5/8"	18 3/4"	birch	AA	2	3/4"	2 3/8"	13 7/8"	birch
J	1	3/4"	5"	18 3/4"	birch	BB	1	3/4"	13 7/8"	23 1/2"	birch plywwod
K	2	3/4"	4"	13 7/8"	birch	CC	2	1/2"	3/4"	14 3/8"	birch
L	1	3/4"	4"	23 1/2"	birch	DD	1	1/2"	3/4"	24 1/2"	birch
M	2	3/4"	2 3/8"	24"	birch	EE	2	3/4"	3/4"	13 7/8"	birch
N	2	3/4"	2 3/8"	13 7/8"	birch	FF	1	3/4"	3/4"	23 1/2"	birch
O	1	1/4"	14 5/8"	20"	birch plywood	GG	3	3/4"	10 1/2"	19 3/8"	birch plywwod
P	1	3/4"	13 3/8"	22 1/2"	birch plywood	HH	6	1/2"	3/4"	11 1/2"	birch
Q	2	1/2"	3/4"	13 7/8"	birch	II	3	1/2"	3/4"	20 3/8"	birch
R	1	1/2"	3/4"	23 1/2"	birch						

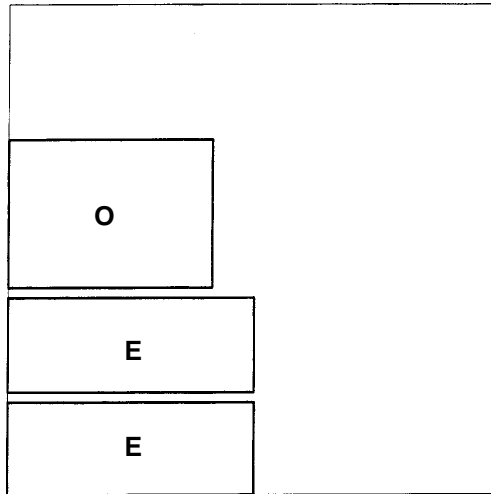

1/4" x 48" x 48"
Birch Plywood Layout

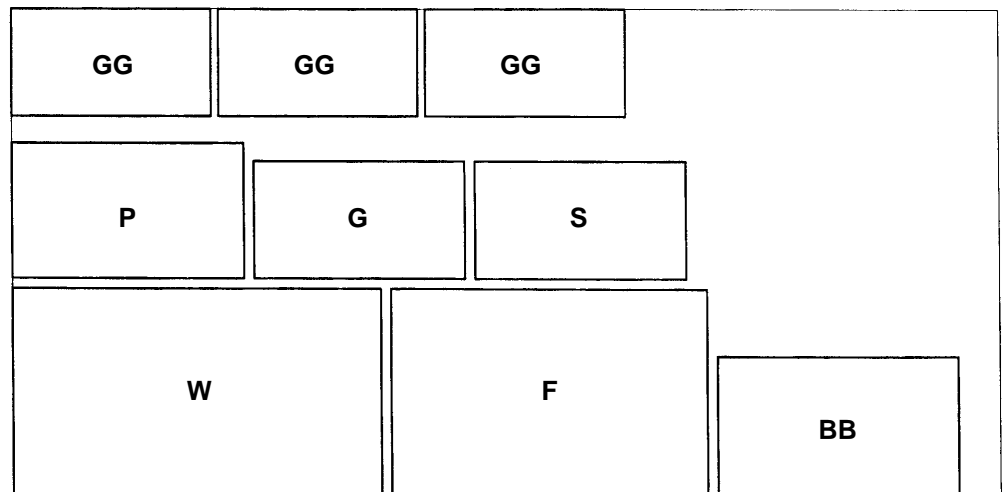

3/4" x 48" x 96"
Birch Plywood Layout

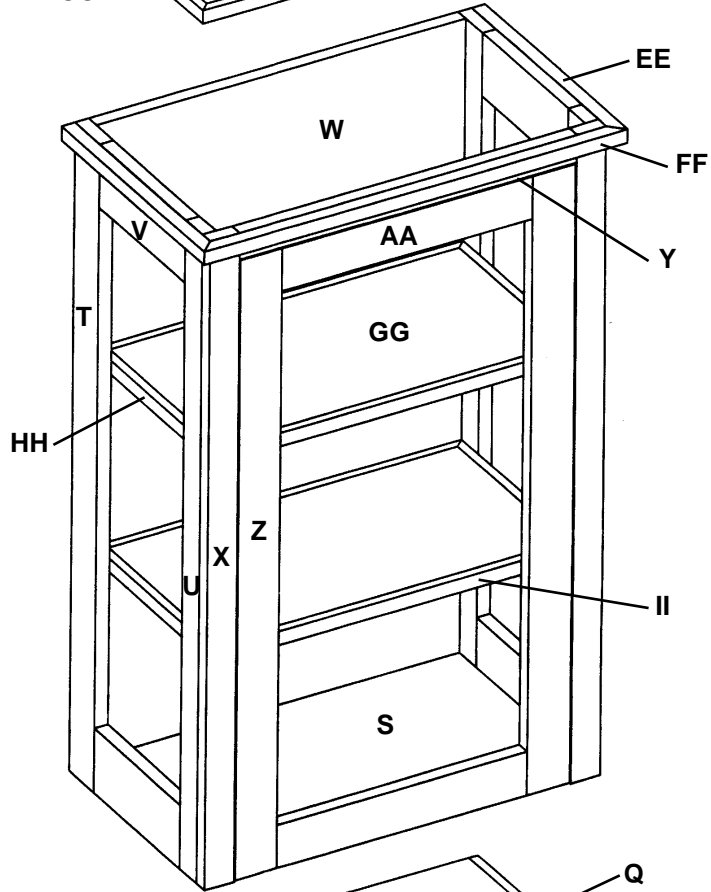
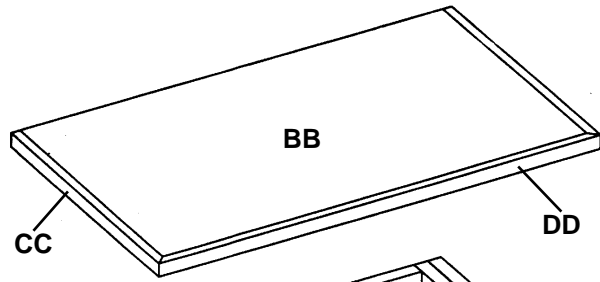

Isometric

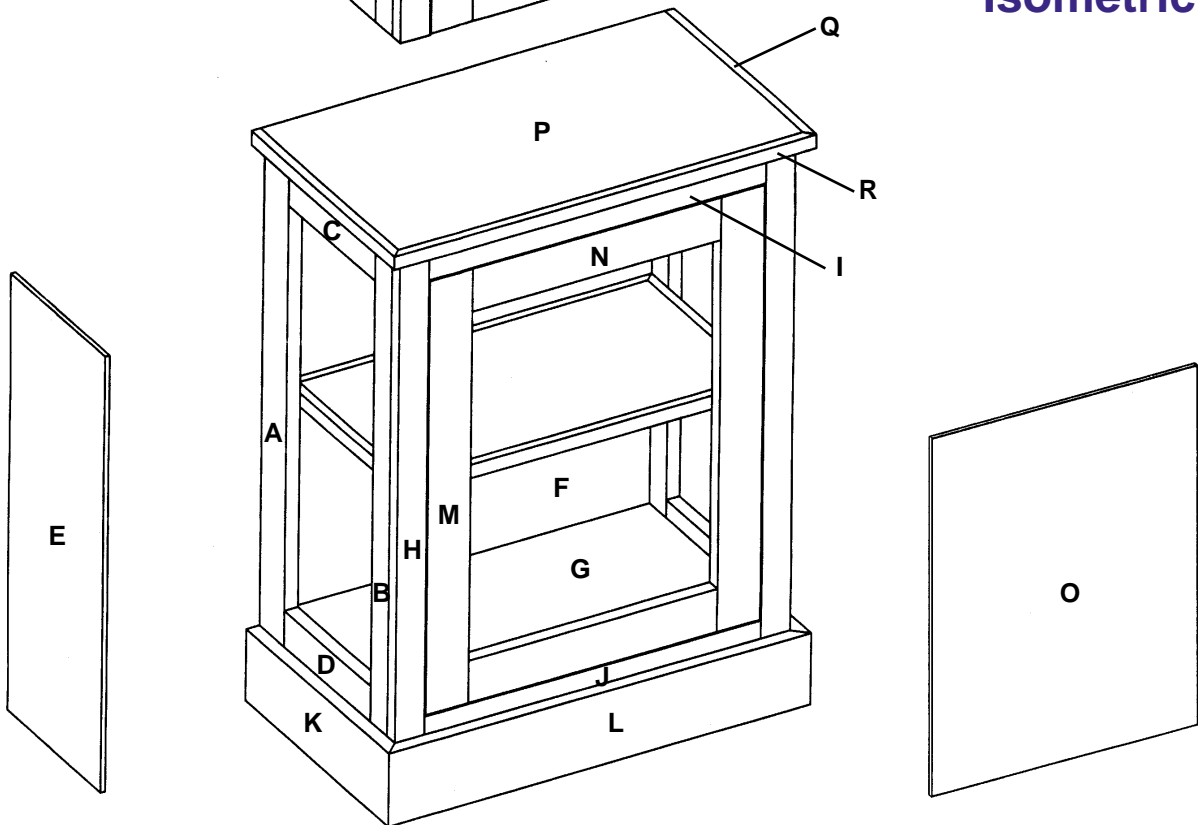

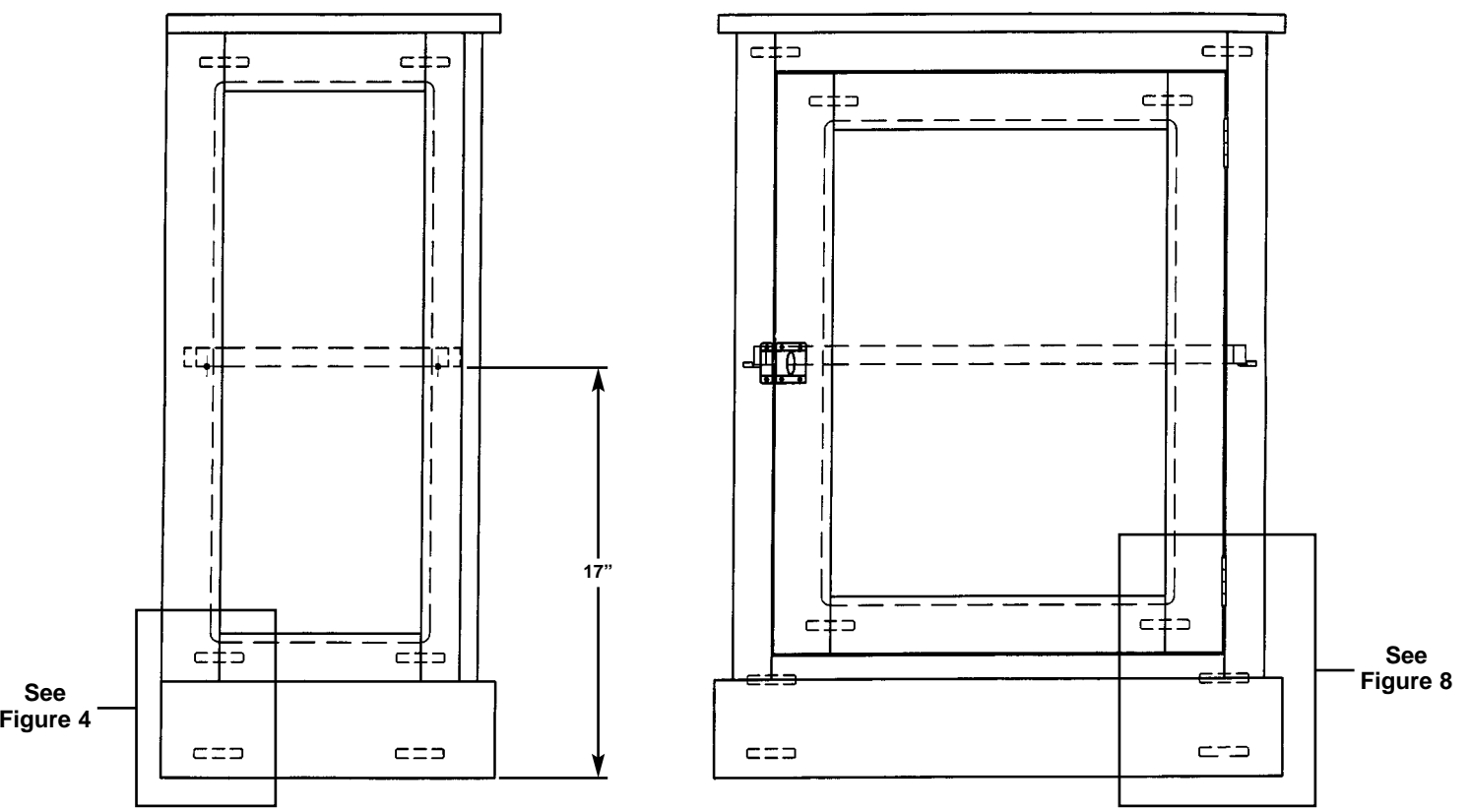
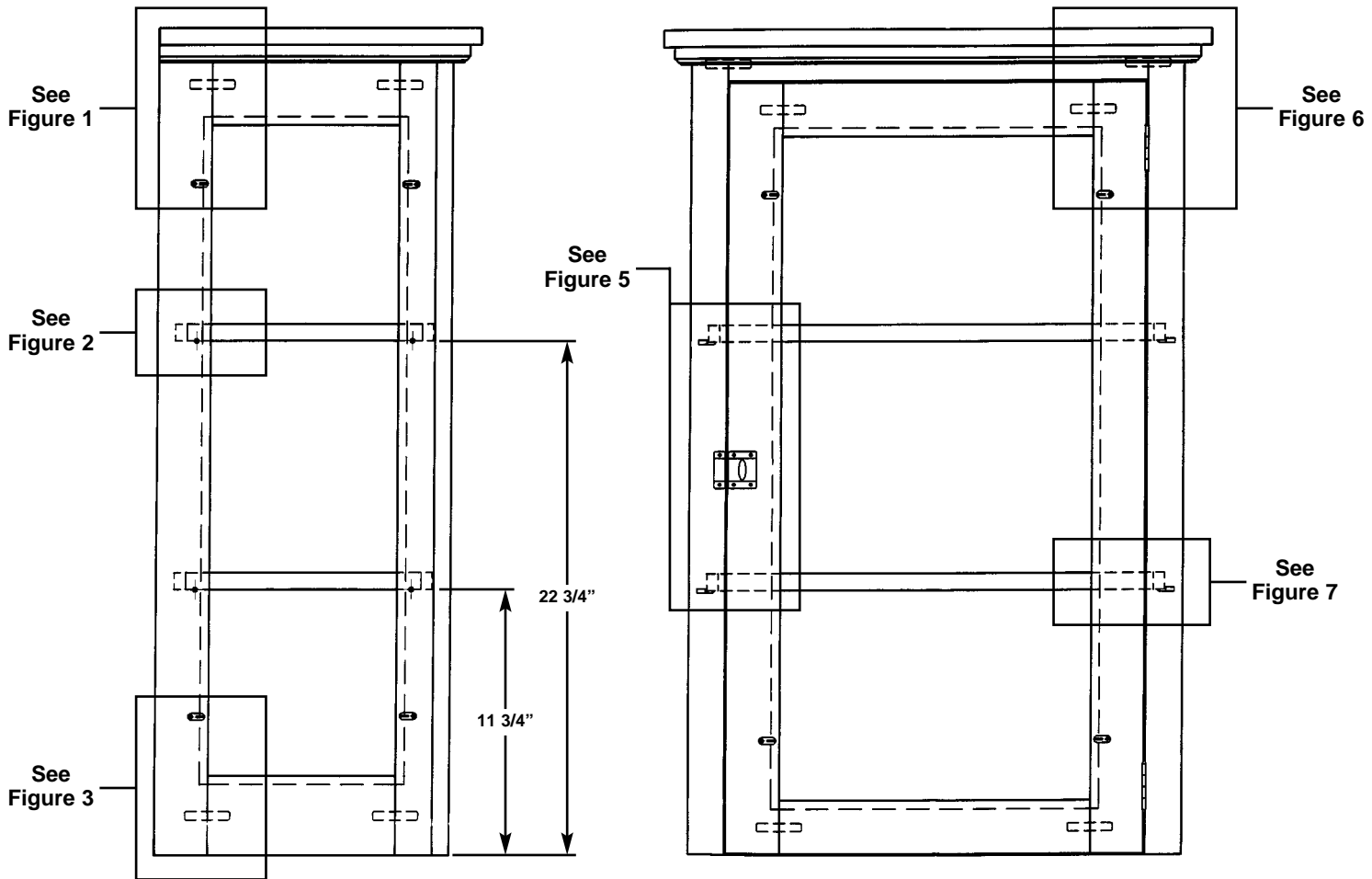

Side & Front Elevations

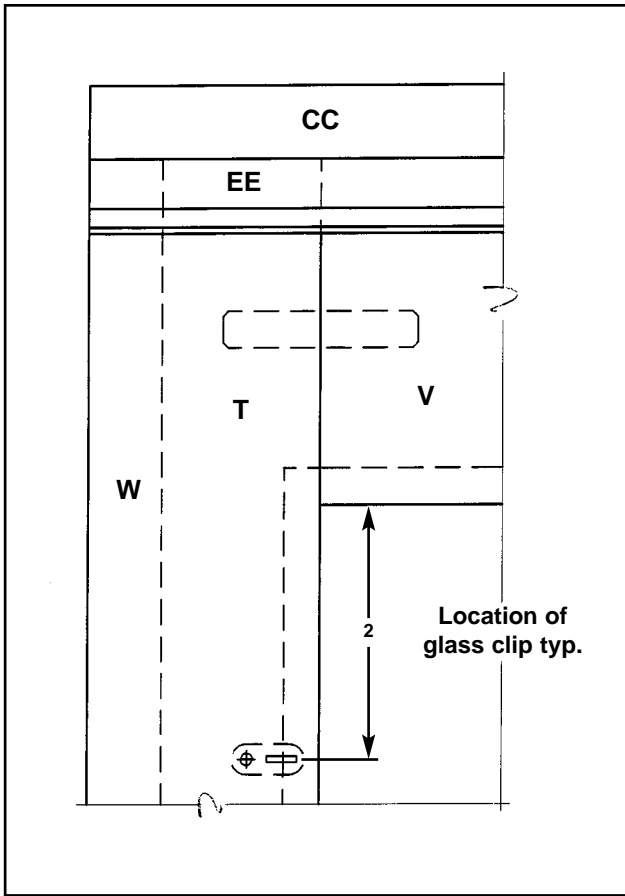

Figure 1

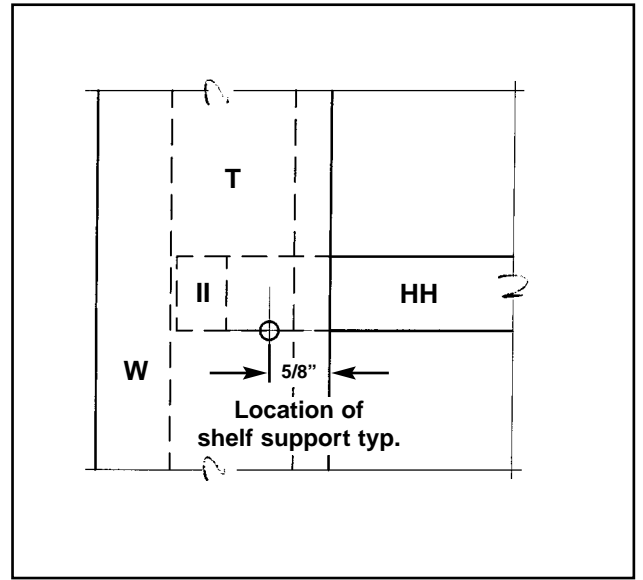

Figure 2

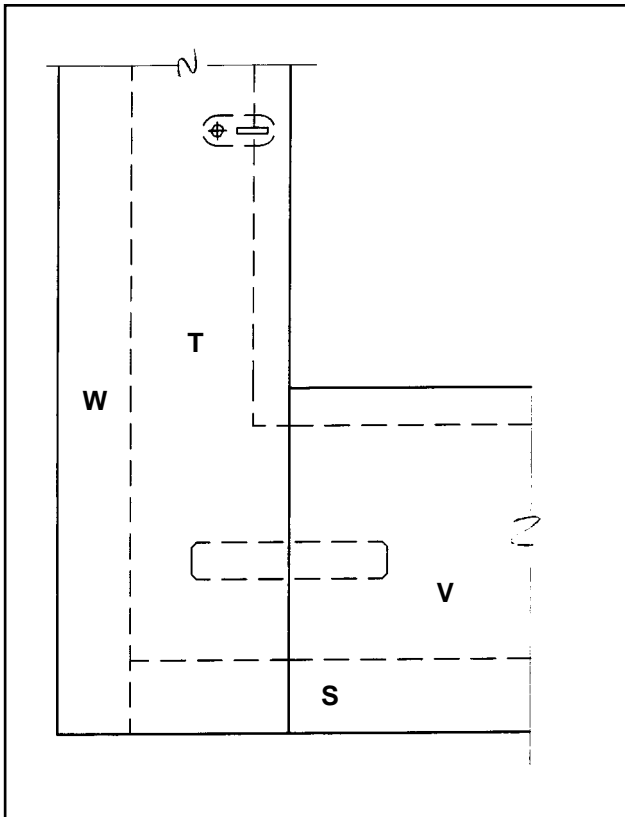

Figure 3

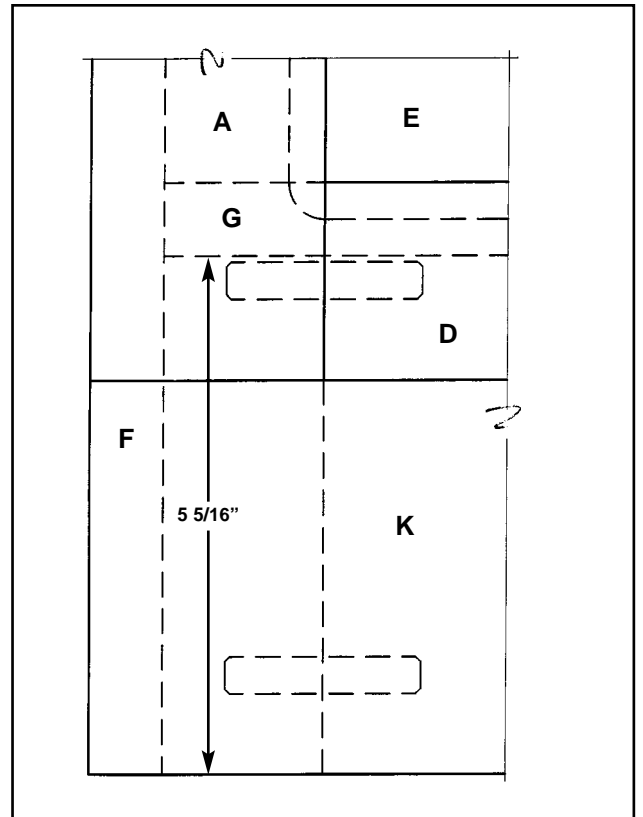

Figure 4

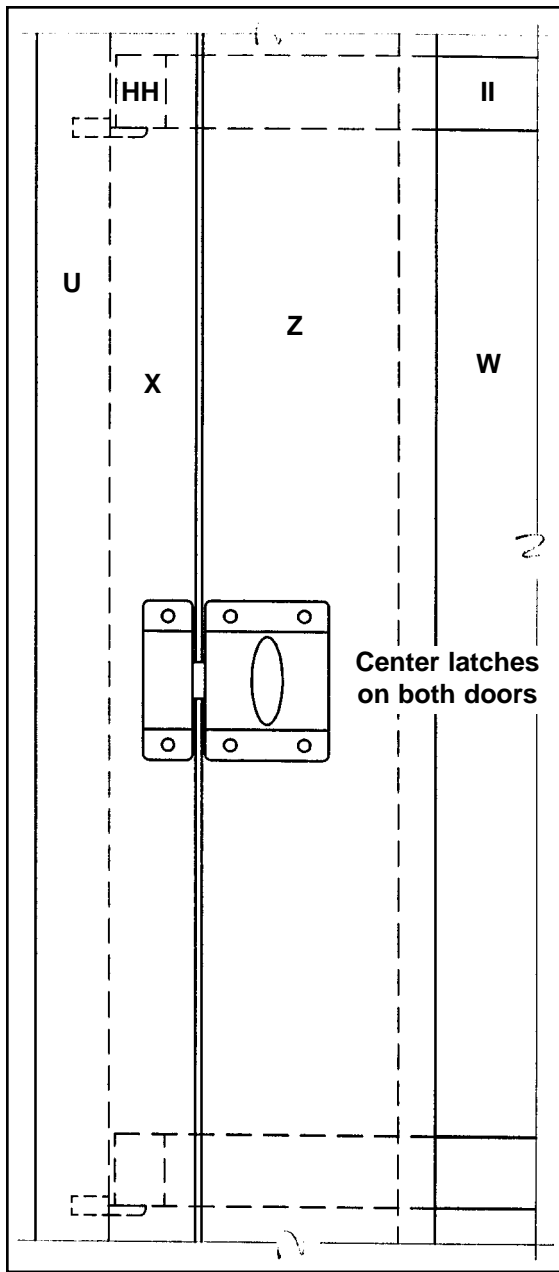

Figure 5

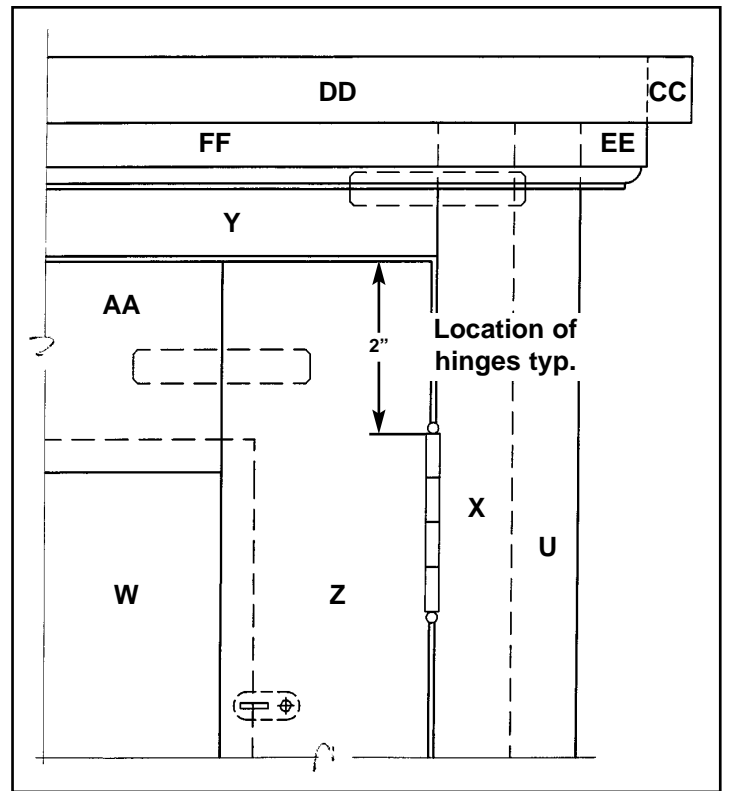

Figure 6

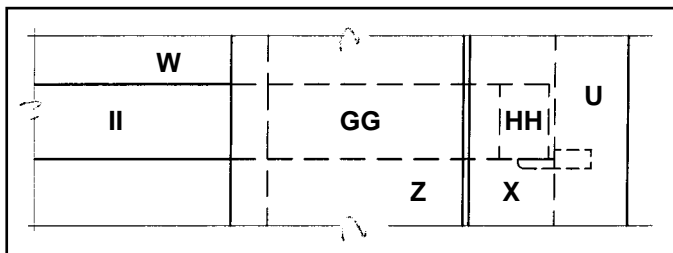

Figure 7

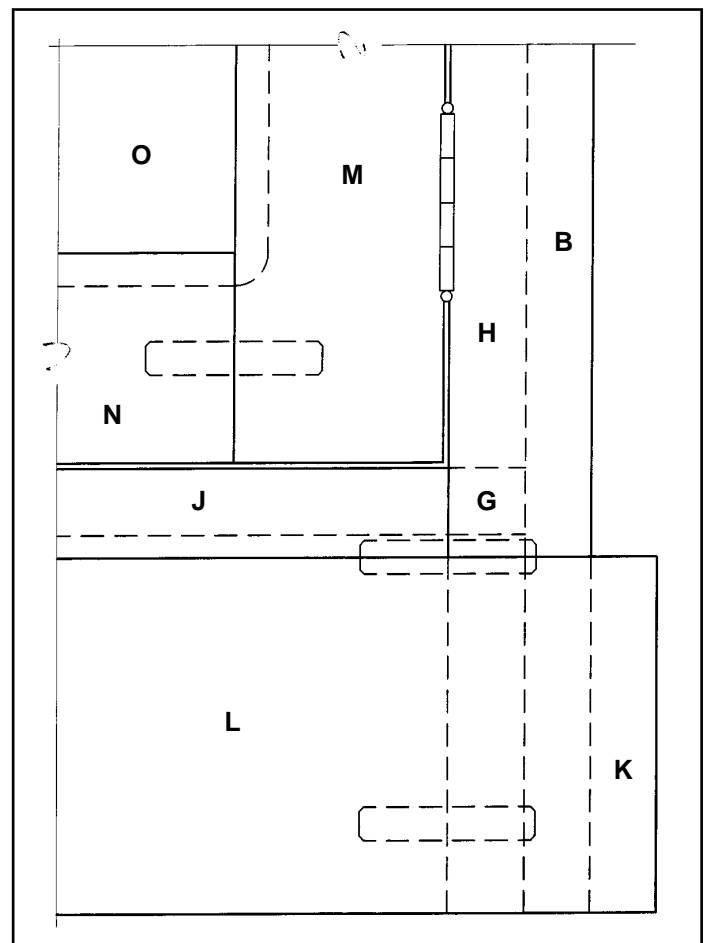

Figure 8

Assembly Instructions

Read all instructions before beginning any work. Cut all material to sizes shown in cutting schedule.

1. Assemble side panel frames (A, B, C, D) and (T, U, V), face frames (H, I, J) and (X, Y) and door frames (M, N) and (Z, AA). Refer to Isometric and Elevations and Figures 1 through 8. Use 3/8" dowels and glue on all joints.
2. Route a 3/8" rabbet inside all side panel and door frames. Note that the corners of the rabbet are cut square in the upper cabinet for the glass panels (see Figures 1 and 3).
3. Locate and drill 1/4" holes for shelf supports. Refer to Elevations and Figure 2.
4. Glue panels E into lower cabinet side frames (A, B, C, D) and panel O into lower cabinet door frame (M, N).
5. Use 1 1/4" finish nails and glue to assemble board G to board F. Refer to Isometric and Figure 4.
6. Nail and glue lower cabinet sides (A, B, C, D, E) to subassembly (F, G). Refer to Isometric and Figure 4.
7. Attach lower cabinet face frame (H, I, J) to boards B using 1 1/4" finish nails and glue. Refer to Isometric and Figure 8.
8. Miter one end of boards K and both ends of board L as indicated in Isometric. Glue boards K and L to the base of the lower cabinet. Refer to Elevations and Figures 4 and 8.
9. Use 1 1/4" finish nails and glue to assemble board S to board W. Refer to Isometric and Figure 3.
10. Nail and glue upper cabinet side frames (T, U, V) to subassembly (S, W). Refer to Isometric and Figures 1 and 3.
11. Attach upper cabinet face frame (X, Y) to boards U using 1 1/4" finish nails and glue. Refer to Isometric and Figures 5 and 6.
13. Miter one end of boards Q and CC and both ends of boards R and DD as indicated in Isometric. Use 1" finish nails and glue to attach R and Q to board P and CC and DD to board BB. Refer to Isometric and Figure 6.
14. Route a decorative edge on boards EE and FF (refer to Figure 6). Miter one end of boards EE and both ends of board FF as indicated in Isometric. Use 1" finish nails and glue to attach EE and FF to the upper cabinet.
15. Miter one end of boards HH and both ends of boards II. Attach boards HH and II to shelves GG using 1" finish nails and glue.
16. Place the upper cabinet on top of the lower cabinet and paint the project.
17. Attach glass clips, hinges and door latches. Refer to Figures 1, 5 and 6. Install glass in upper cabinet.